

**OPTION 1**

FOR USE IN:  
SYSTEM MAT INTERCONNECT  
BUMPER REQUIRING CONNECTORS  
EDGES REQUIRING CONNECTORS

MOLEX OR EQUIVALENT  
TERMINAL, MALE P/N 13355  
(02-06-2103)

MOLEX OR EQUIVALENT  
CONN, PLUG  
P/N 13354

MOLEX OR EQUIVALENT  
CONN, RECEPT  
(03-06-1023)  
P/N 13353

MOLEX OR EQUIVALENT  
TERMINAL, FML P/N 13356  
(02-06-1103)

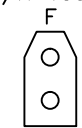
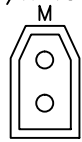

USING 2 CONDUCTOR WIRE

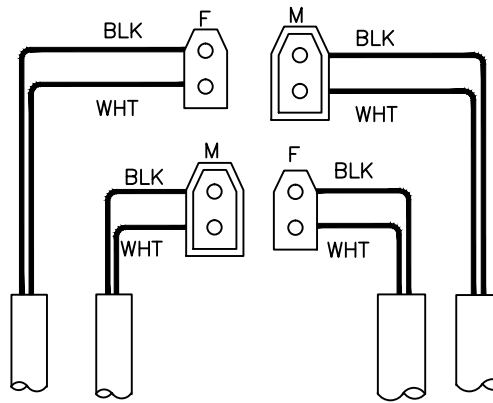

USING 4 CONDUCTOR WIRE

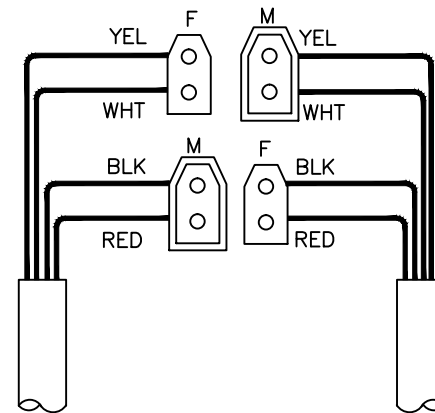

REV.	DESCRIPTIONS	DATE	APPRO.
A	PER ECN 08-45	7-14-08	ADR
B	PER ECN 08-100	12-19-08	ADR
C	PER ECN 10-69	9-29-10	ADR
D	OPT. 2B ADDED, DNF18-250M	5/24/11	ADR
E	PER ECN 13-90	10/22/13	

**OPTION 2**

FOR USE IN:  
SINGLE WIRE CONNECTIONS

PANDUIT OR EQUIVALENT  
(DNF-18-250 FIM)

PANDUIT OR EQUIVALENT  
(DNF-18-250M)

A)

B)

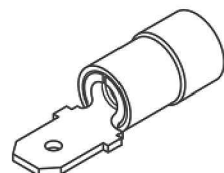
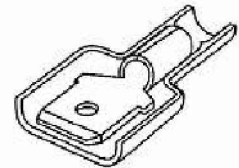

PANDUIT OR EQUIVALENT  
(DNF-18-250 FIB-M)

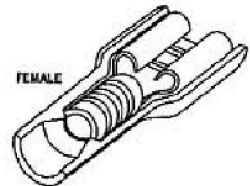

**OPTION 4**

FOR USE IN: DISCRETE WIRE  
CONNECTIONS WITH LIMITED ACCESS

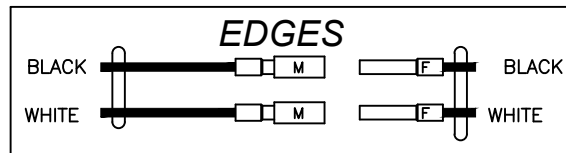
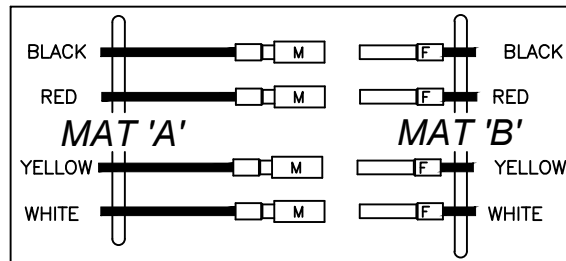

MALE PLUG TS P/N 13368  
FEMALE SOCKET TS P/N 13369

**OPTION 6**

FOR USE IN: MAT OR EDGE LEADS  
WITH 20/4 OR DOUBLE ZIPCORD WIRES  
INTERNAL SOLDER CUP CONNECTIONS.

M12-4 MALE - TAPESWITH No 13322

20/4 Ø3/16 WIRING

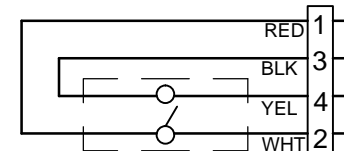

22/2 DOUBLE ZIPCORD WIRING

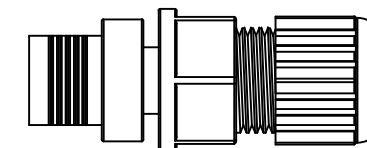
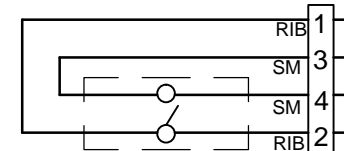

TE CONN. OR EQUIVALENT  
(1838275-2)



- NOTES FOR OPTIONS 1 THRU 4:
1. SOLDERLESS, CRIMPED ON CONNECTIONS.
  2. FOR 18 AWG - 22 AWG INSULATED WIRE.
  3. FOR MAT INTERCONNECTS USE 20/4 CABLE P/N 10482.

- NOTES FOR OPTION 5:
1. PREFLUXED SOLDER SLEEVE.
  2. FOR 18 AWG - 22 AWG INSULATED WIRE.

**OPTION 3**

FOR USE IN:  
CONVEYOR BUMPER

KOBECONN OR EQUIVALENT  
(159-1501)  
P/N 14346

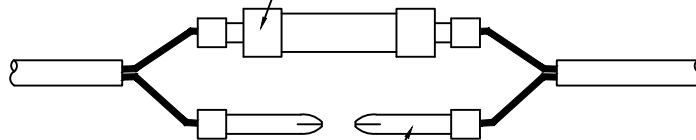

P/N 14345

KOBECONN OR EQUIVALENT  
(159-3156)

**OPTION 5**

SOLDER SLEEVE TS P/N 13312  
MOUSER #650-CWT900L OR EQUIVALENT

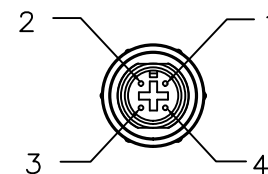
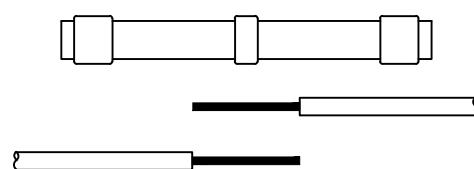

PART #:

MAT'L:

CONNECTOR OPTIONS

**TAPESWITCH CORPORATION**

FARMINGDALE, NEW YORK, U.S.A.

SCALE N/A DRAWN S. KLUG  
APPD ADR DATE 5-7-08

SIZE B DRAWING NUMBER P08-4-4